



Lecture 4

- What is squeezed light ?
 - Formalism
 - Properties
- Examples of experiments

Other possible states

Coherent state
 $V_1 = V_2$

$$V_1 V_2 = 1$$

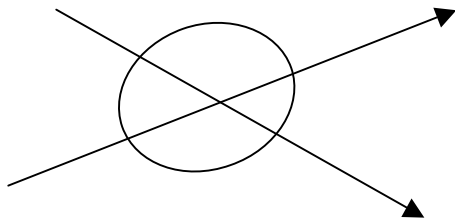
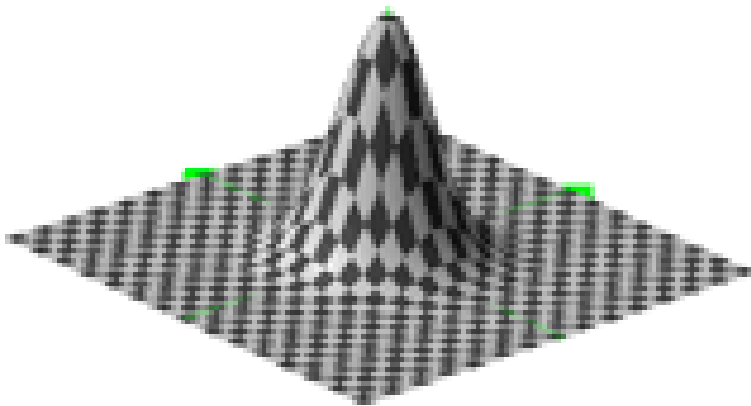

Squeezed state
 $V_1 \neq V_2$

$$V_1 V_2 \geq 1$$

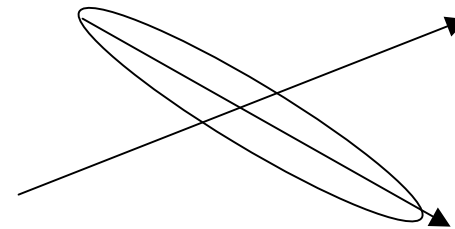
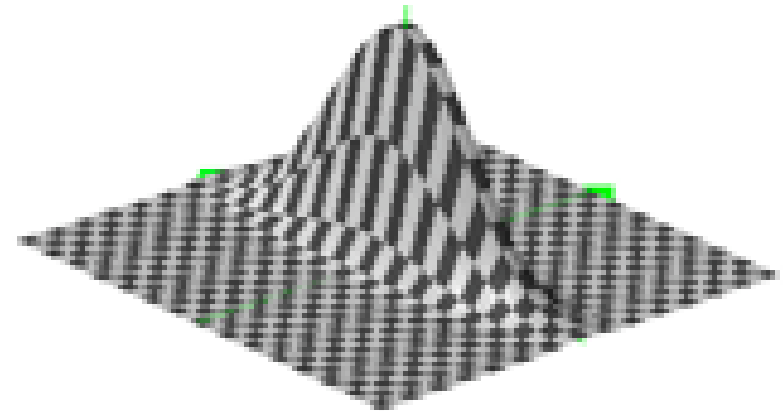

Squeezed states

Theoretically they are a different class:

$$|\alpha, \xi\rangle = S(\xi) D(\alpha) |0\rangle$$

2 photon correlated state, displace first,
then apply squeezing operator Yuen

$$|\alpha, \xi\rangle = D(\alpha) S(\xi) |0\rangle$$

squeezed state, squeeze first,
then apply displacement operator Walls

$\xi = r$ degree of squeezing, Θ_s squeezing angle

Photon distribution for squeezed light

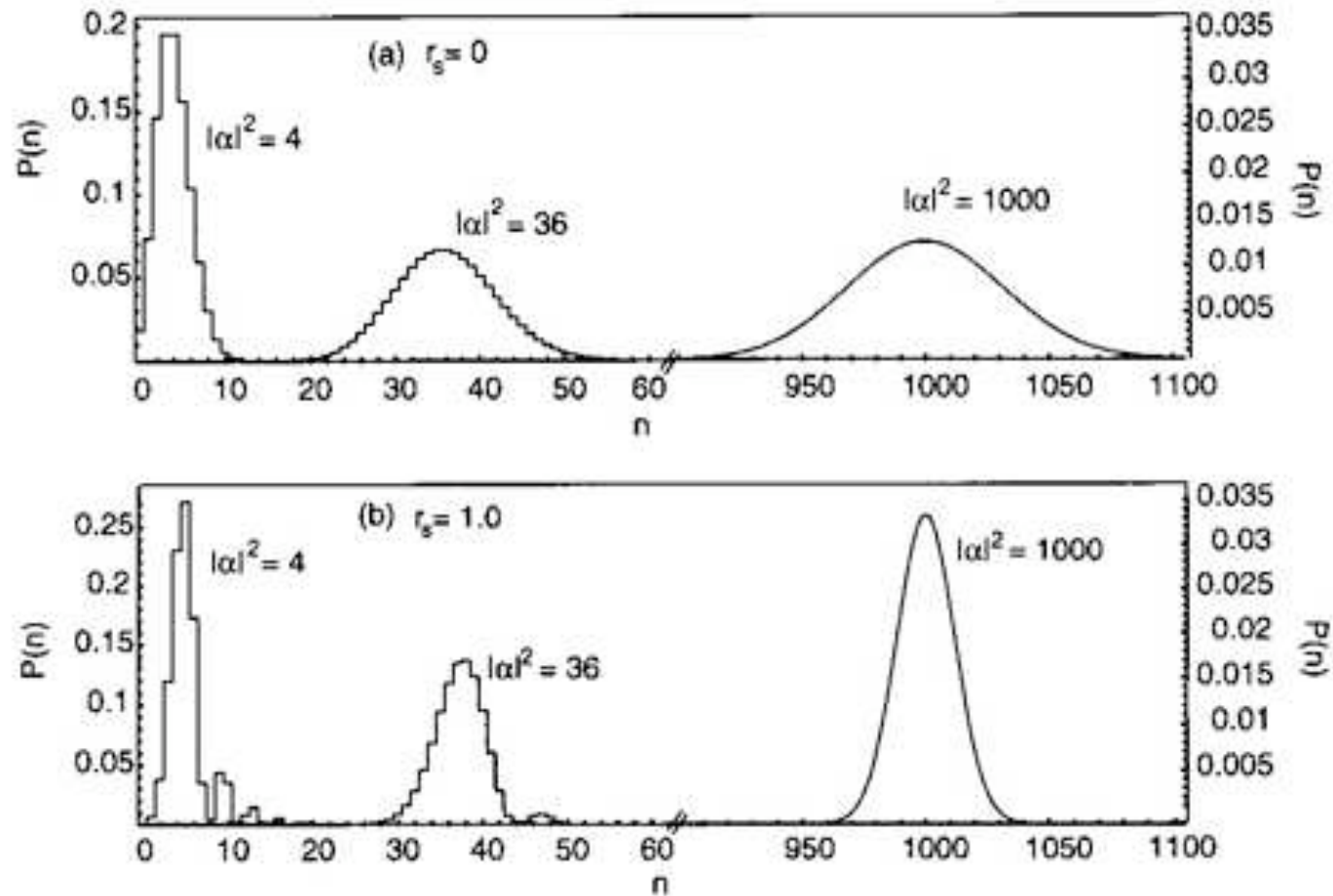

Comparison of coherent state with squeezed state ($r=1$), for three different mean photon numbers: $|\alpha|^2 = 4, 36$ and 1000 . For low photon numbers there is structure, for high photon numbers we get a narrower Gaussian.

A model for squeezing

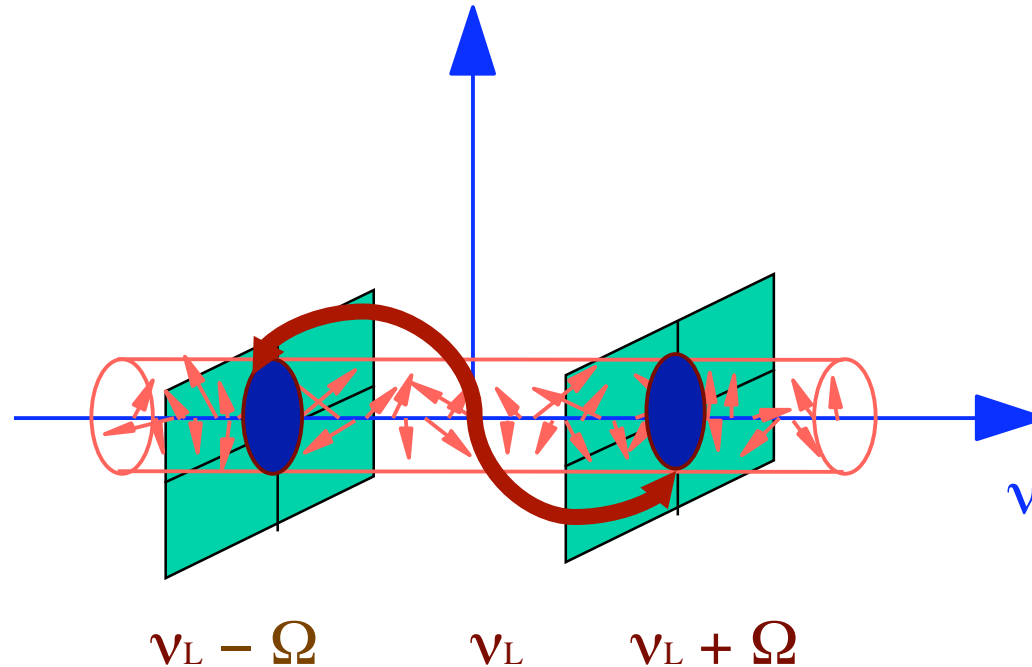

The two sidebands are no longer independent. The nonlinear process couples, correlates, the two side bands. These are both contributing to the beat frequency detected at Ω .

The two contribution can cancel each other \Rightarrow noise $<$ QNL

Squeezing properties

The noise depends on the detection angle Θ

$$\text{Var} (X(\Theta)) = \cosh^2(r) - |\sinh(r) \exp(i 2(\Theta + \Theta_s))|^2$$

it is best to go into a rotated frame of reference

$$VY1 = \text{Var} (X(\Theta_s)) = \exp(-2r)$$

$$VY2 = \text{Var} (X(\Theta_s + \pi/2)) = \exp(2r)$$

and note that both $\Theta_s(\Omega)$ and $r(\Omega)$ depend on the detection frequency

Plotting $\text{Var} (X(\Theta_s))$

$$\text{VY1} = \text{Var} (X(\Theta_s)) = \exp(-2r)$$

$$\text{VY2} = \text{Var} (X(\Theta_s + \pi/2)) = \exp(2r)$$

(a) linear scale, both squeezing and anti-squeezing

(b) logarithmic scale squeezing occurs in a very narrow range of projections

(c) polar plots of $\text{Var} (X(\Theta_s))$

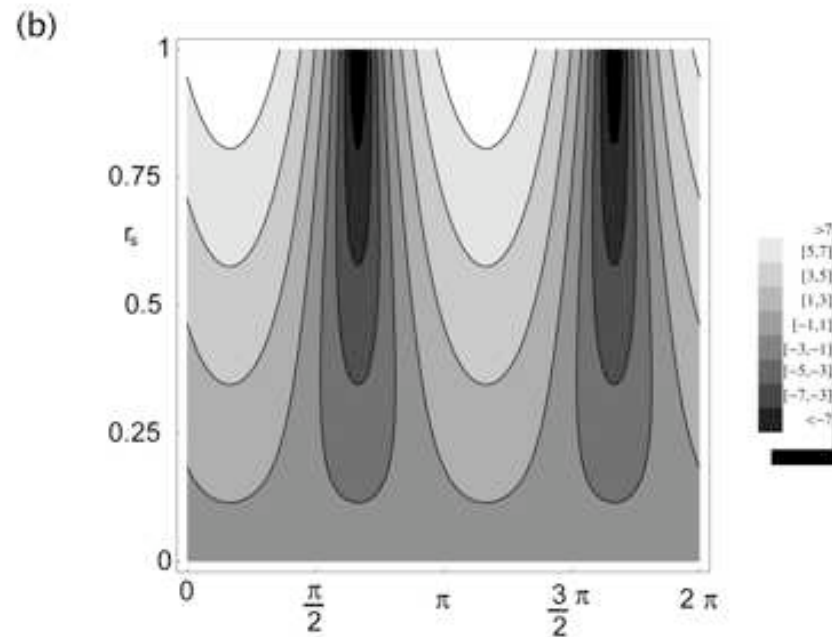
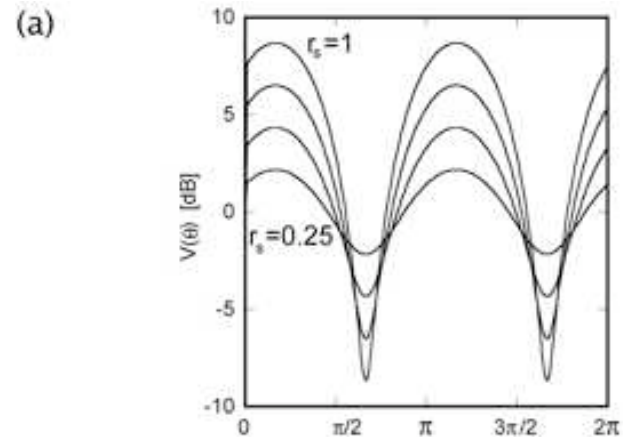

Different types of squeezed states

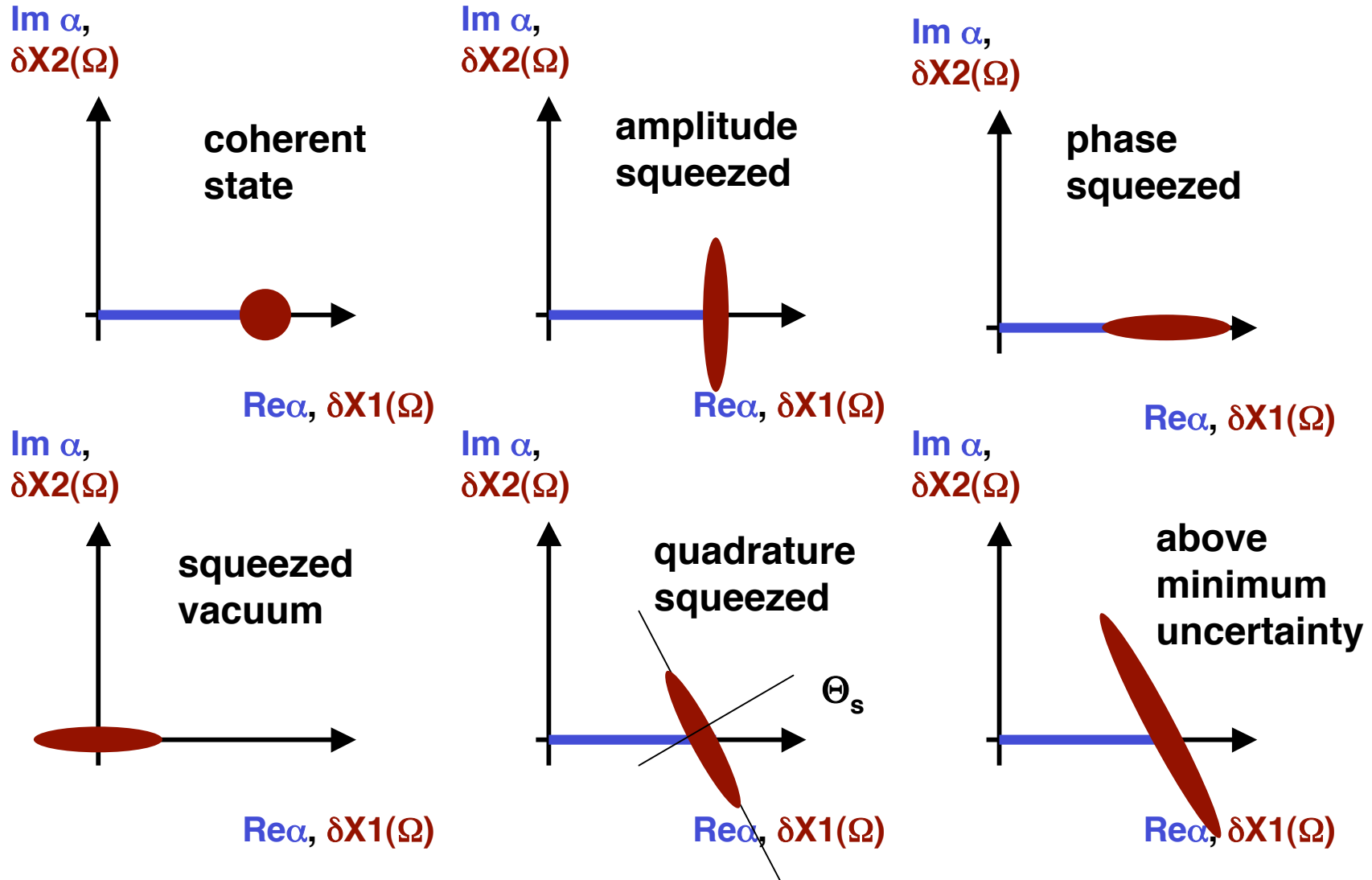

The tools for squeezing

- Is it possible to change the shape of the minimum uncertainty circle using some optical tools?

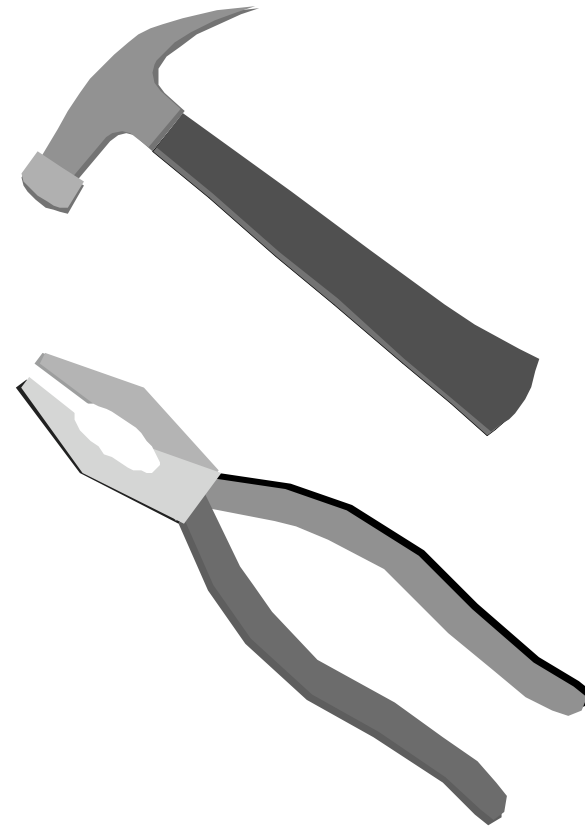
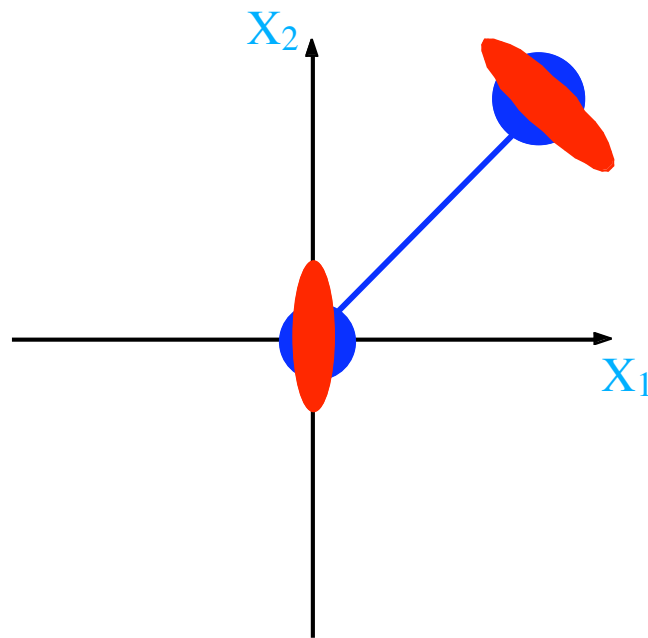

- Can we make a light state that is quieter than the vacuum state of light?
--- **A Squeezed Vacuum** 9



First squeezing results (4WM in Na)

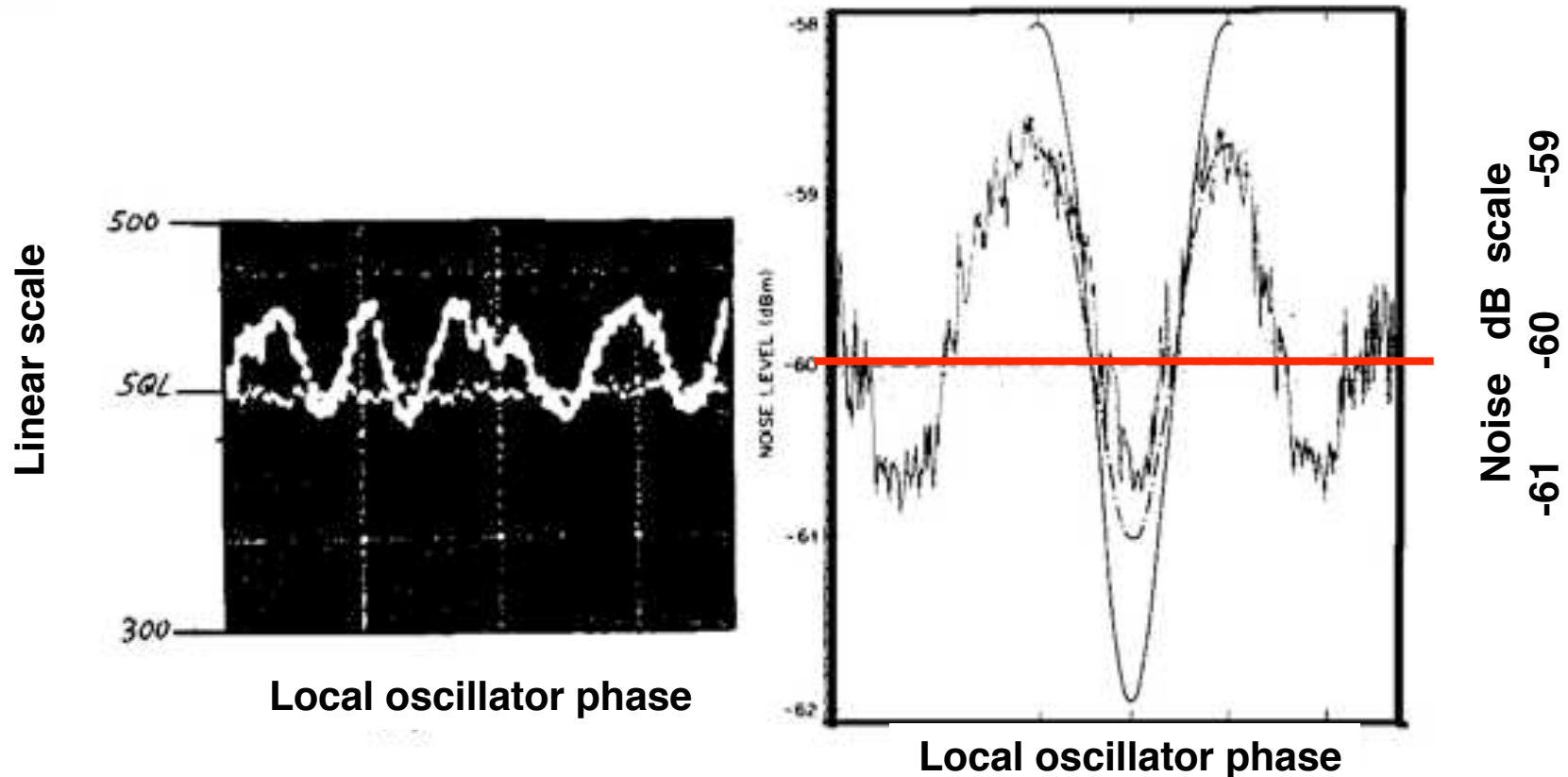

The first squeezing results, obtained at Bell labs by 4WM in a sodium vapour and later results after optimisation. Solid line: theory prediction.

R.E.Slusher, L.W.Hollberg, B.Yurke, J.C.Mertz, J.F.Valley, PRL 55, 2409 (1985)

R.E.Slusher, B.Yurke, P.Grangier, A.LaPorta, D.F.Walls, M.Reid, J.O.S.A. B4, 1453 (1987)

Squeezing with nonlinear processes

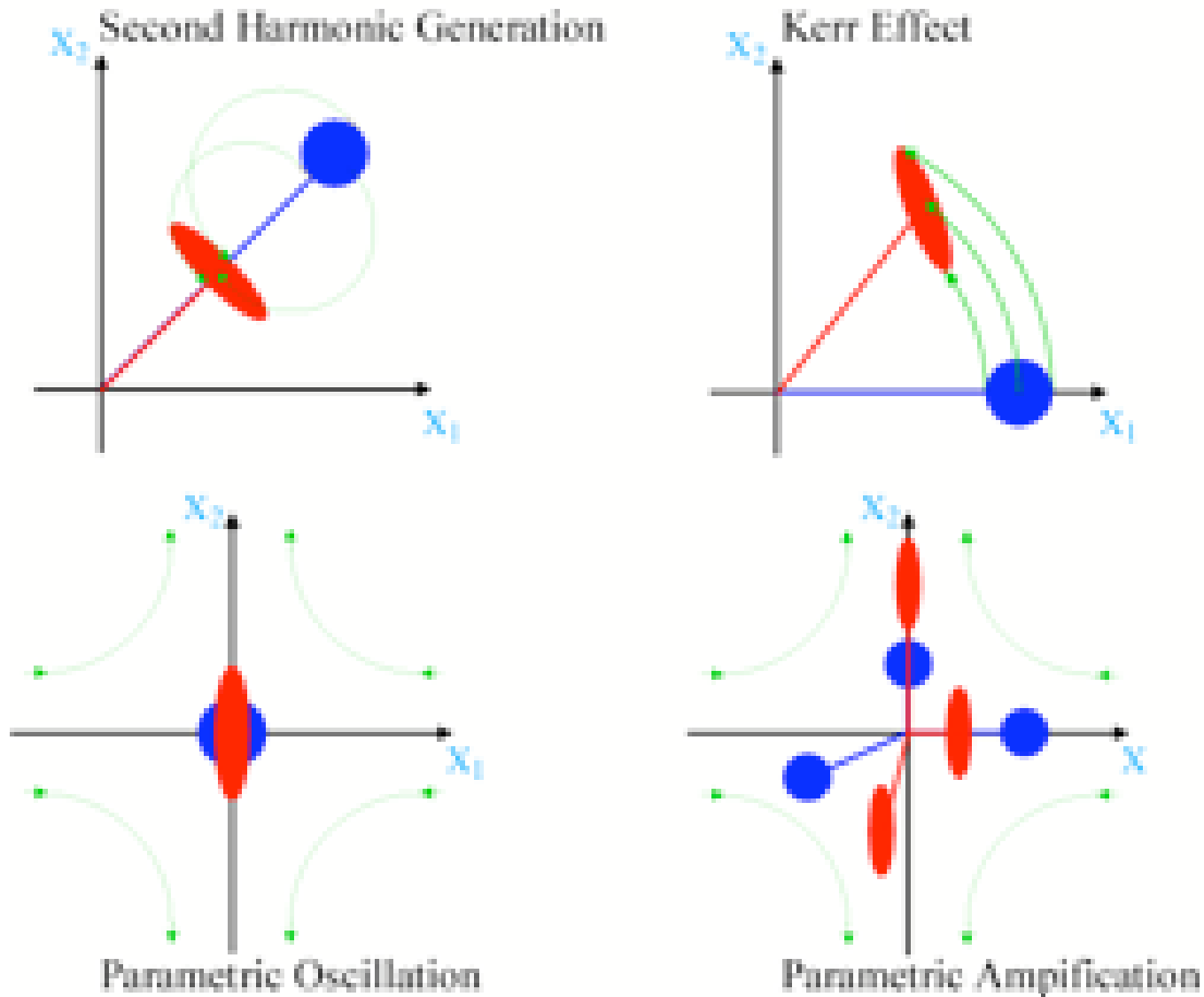

The Kerr effect

The Kerr effect links the fluctuations in the intensity to changes in the refractive index.

The Kerr effect does not preserve minimum uncertainty states. It adds noise.

But: in one direction the noise is below the quantum limit.

$$n(\alpha) = n_0 + n_2 \alpha^2$$

$$\Phi_{\text{out}} = 2 \pi L / \lambda (n_0 + n_2 (\alpha + \delta X_1)^2)$$

$$\delta X_{2,\text{out}} = \delta X_{2,\text{in}} + 2 r_{\text{kerr}} \delta X_{1,\text{in}} \quad r_{\text{kerr}} = 2 \pi n_0 n_2 L \alpha^2 / \lambda$$

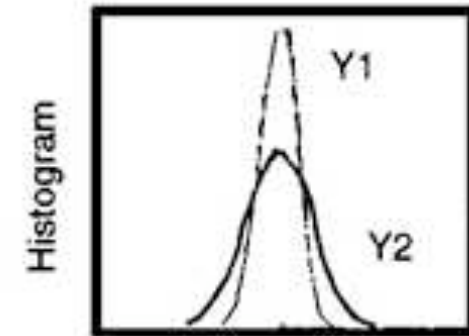
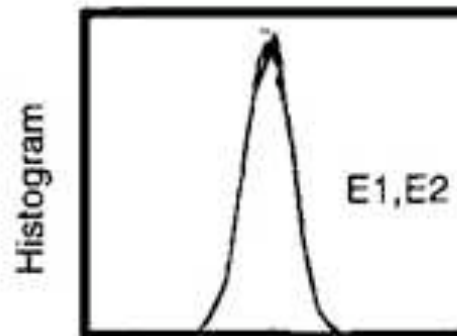
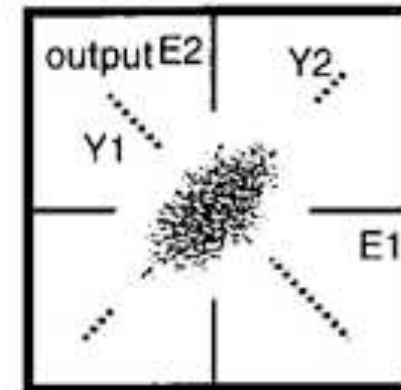
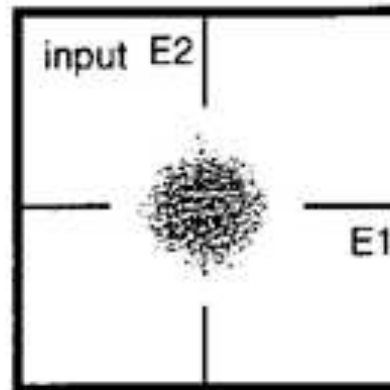

Kerr effect in a fibre

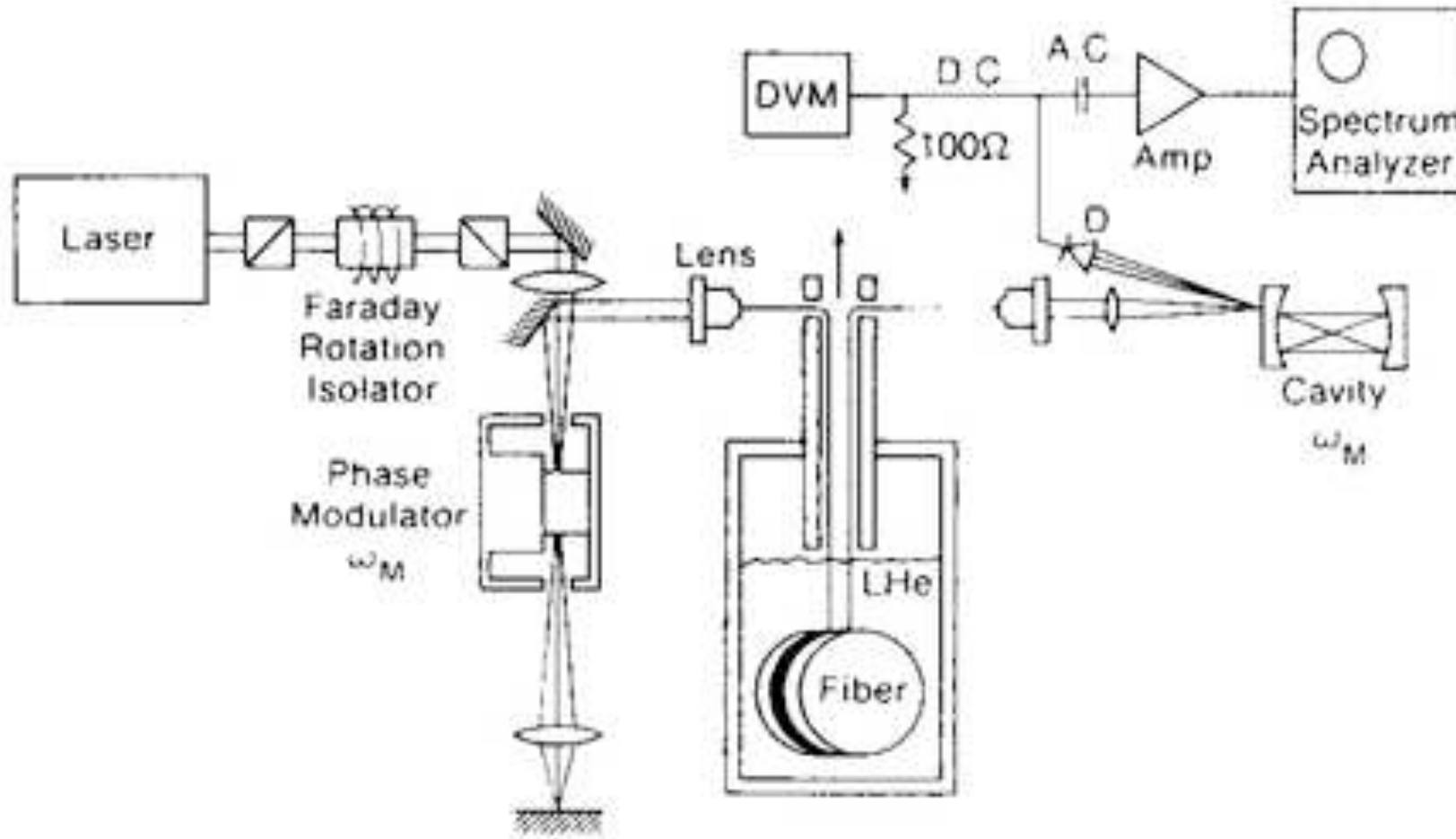

First experimental results with Kerr effect: long fibre , cooled to suppress noise, many modes to avoid Brillouin scattering, detected by rotating the quadratures with a cavity. *M.Levenson , R.M.Shelby, S.H.Perlmutter , Opt.Lett. 514 (1985)*

First Kerr squeezing results

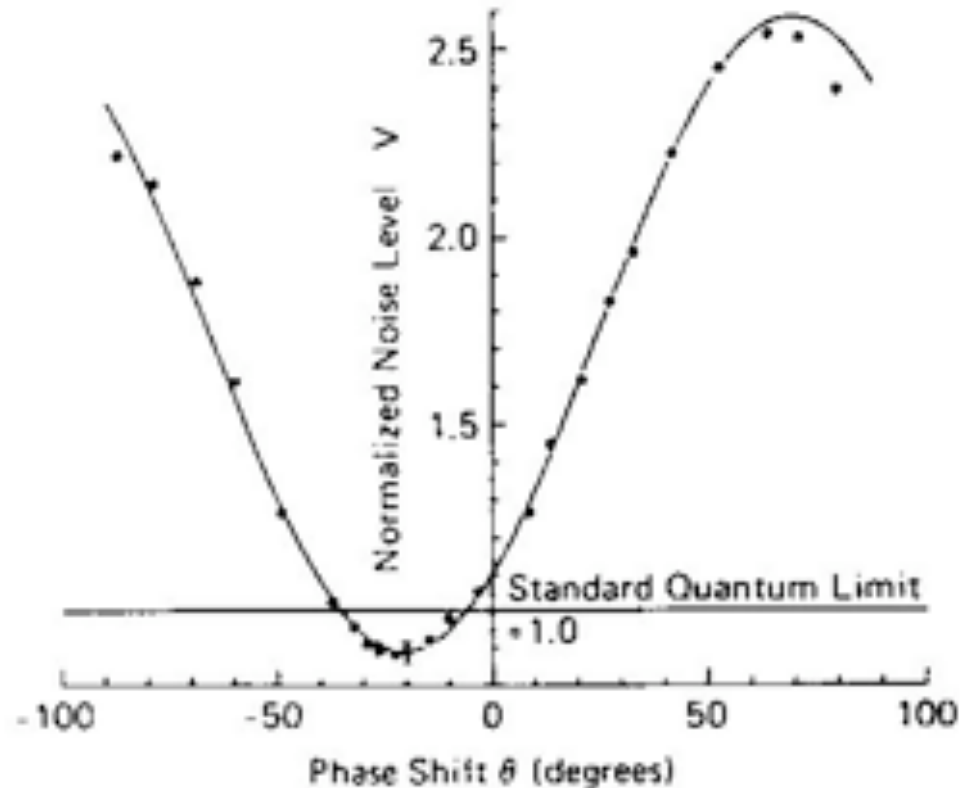

The minimum of the noise is at an angle rotated to X1 and X2. This can be measured by using a detuned cavity to rotate the quadratures. The noise suppression is small, but reproducible and fits the theoretical prediction.

*G.J.Milburn, M.D.Levenson, R.M.Shelby, S.H.Perlmutter, R.G.deVoe, D.F.Walls
J.O.S.A. B 4, 1476 (1987)*

SHG squeezing idea



Nonlinear crystal can convert from ν_1 to $2\nu_1$

cavity which is resonant for fundamental (1063 nm)
has one reflector for the second harmonic (532 nm)

$$d a_s / dt = - (\kappa_{f1} + i\Delta f) a_s + 1/2 \xi a_f^\dagger a_f + \sqrt{2} \kappa_1 A_{s1} + \sqrt{2} \kappa_2 A_{s2} + \sqrt{2} \kappa_{loss} A_{loss}$$

$$V1s(\Omega) = 1 - 8 \kappa_{nl}^2 - 8 \kappa_{nl} \kappa_{nf} (V1_{las} - 1) / [(3 \kappa_{nl} + \kappa_{nf})^2 + (2 \pi \Omega)^2]$$

$$\kappa_{nl} = \xi / 2 \kappa_s |\alpha|^2$$

SHG squeezing apparatus

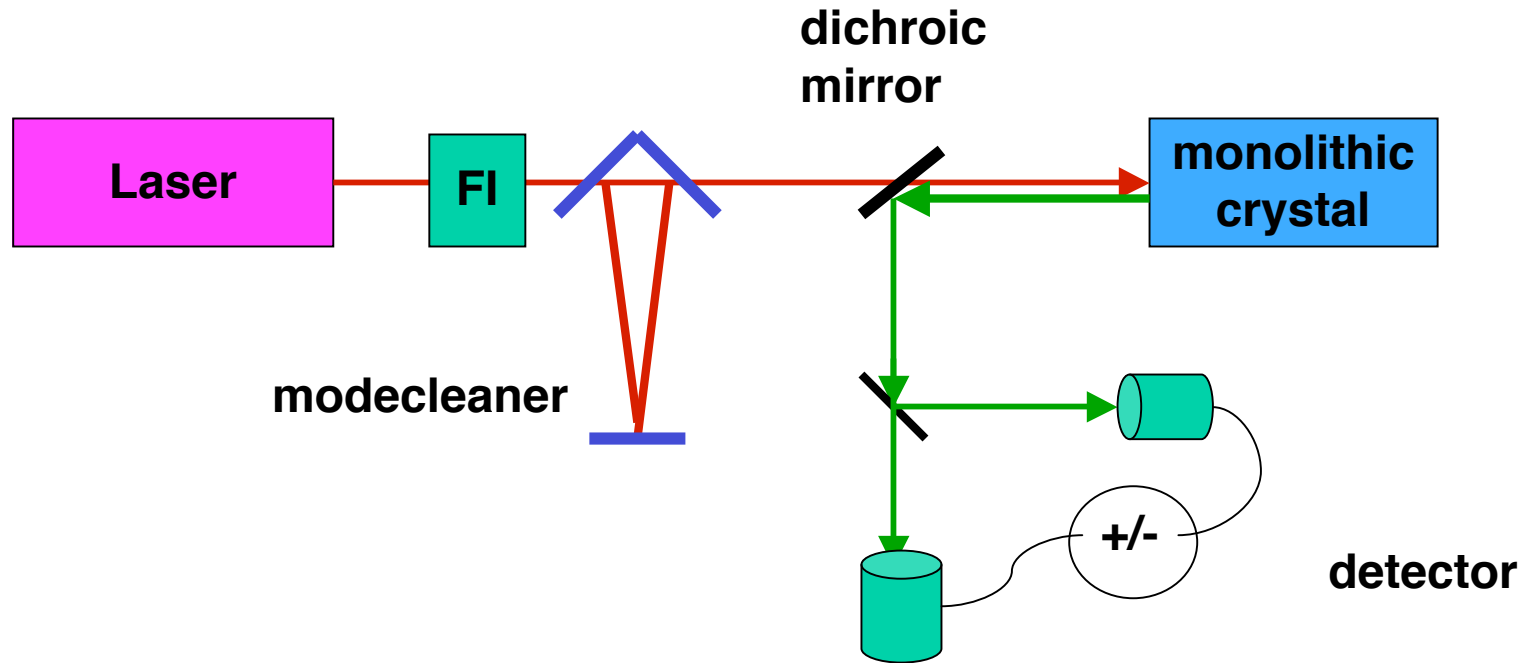



SHG results

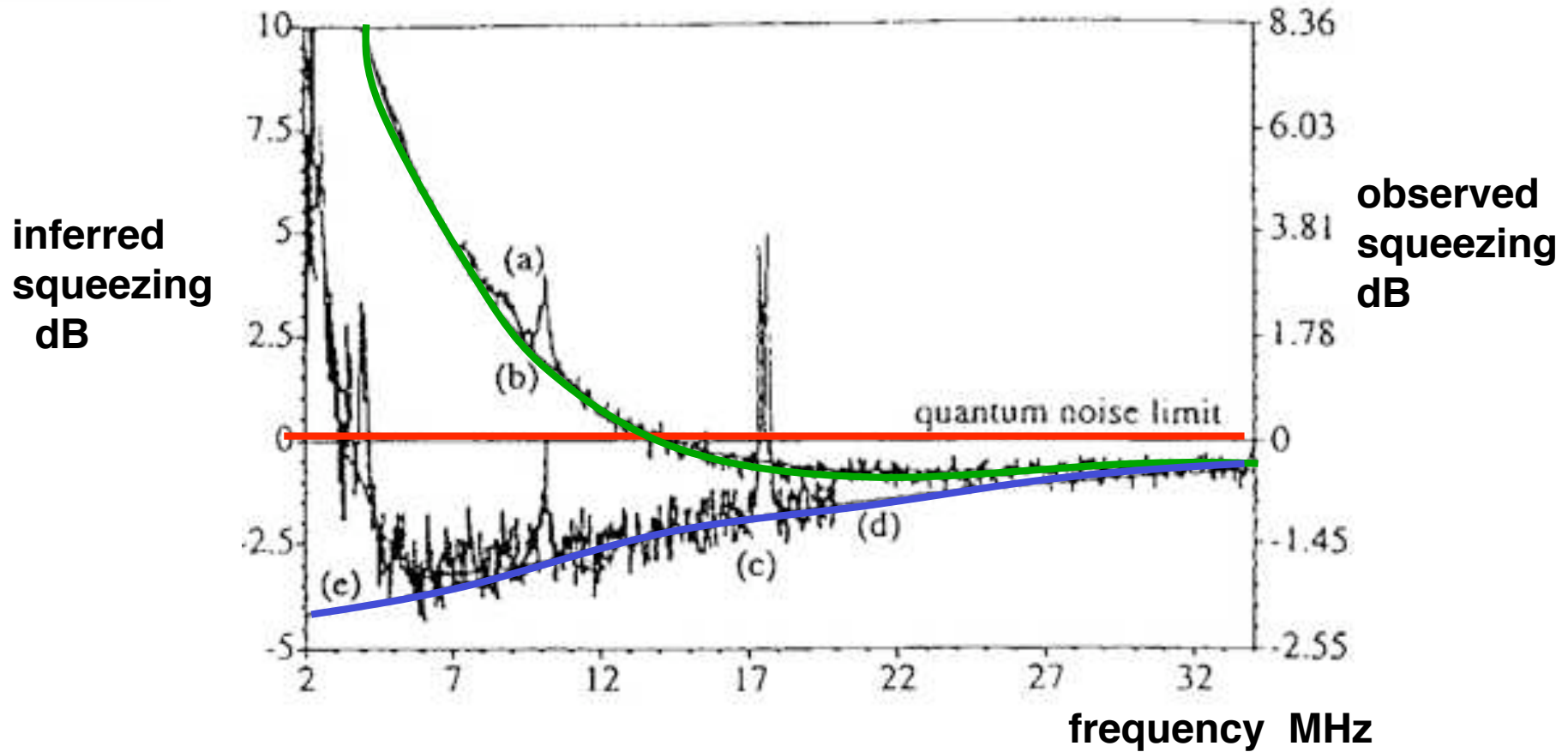

(a) theory (b) experiment **no mode cleaner**
(c) theory (d) experiment **with mode cleaner**

Details of the SHG experiment

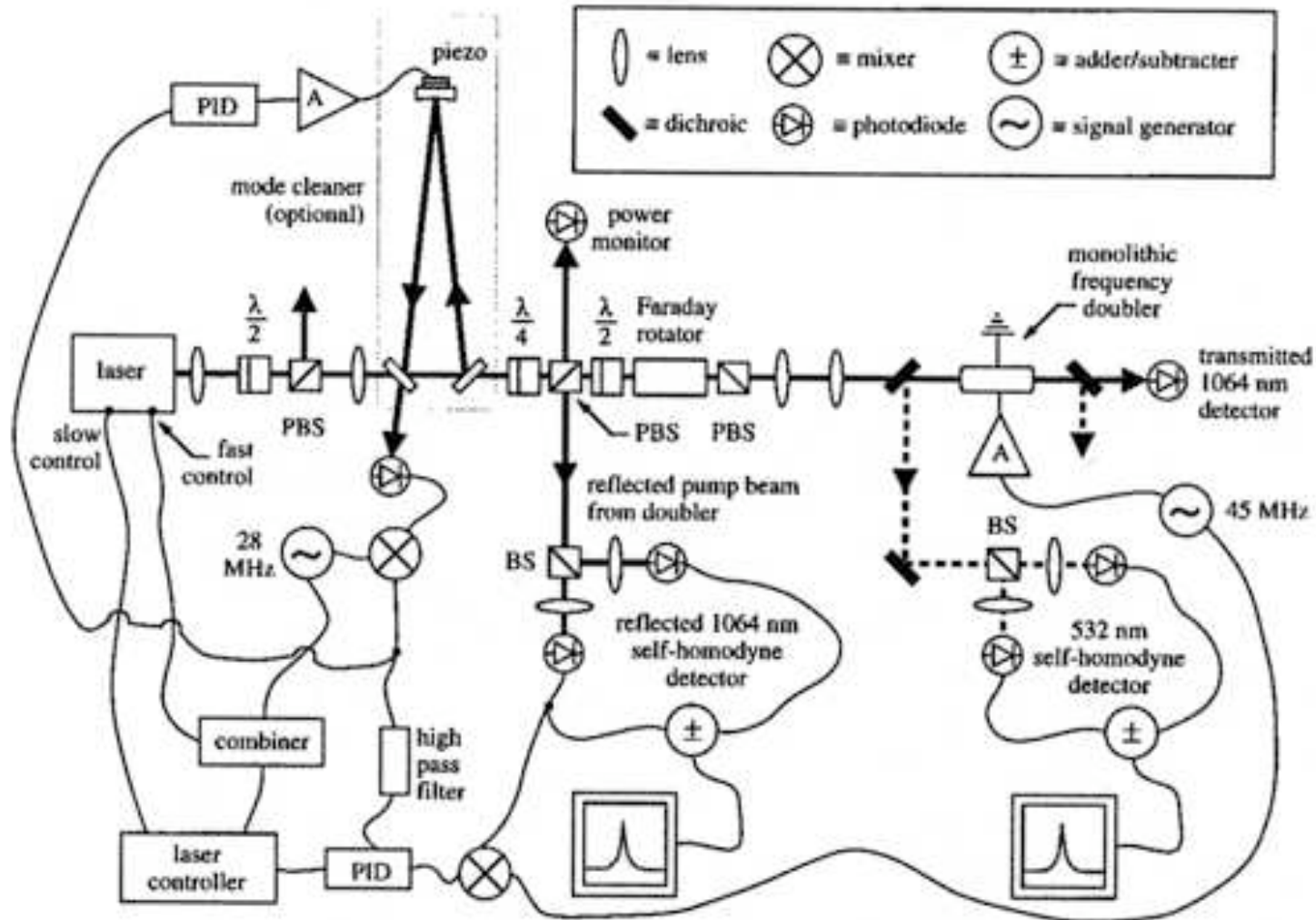

The principle of the OPO

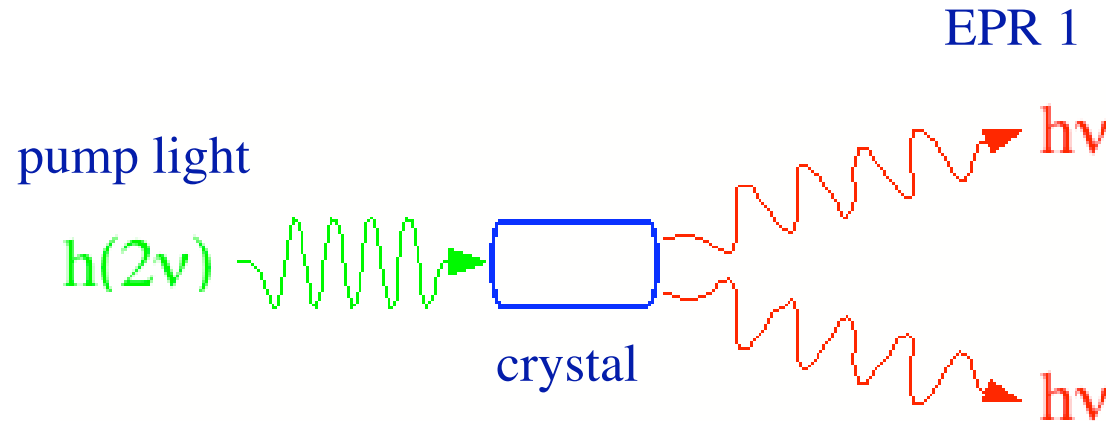

- A device with phase dependent gain.
- When vacuum fluctuation is in phase with the pump, it is amplified.
- When vacuum fluctuation is out-of-phase with the pump, it is de-amplified.
- It works even with a vacuum seed.

EPR 2

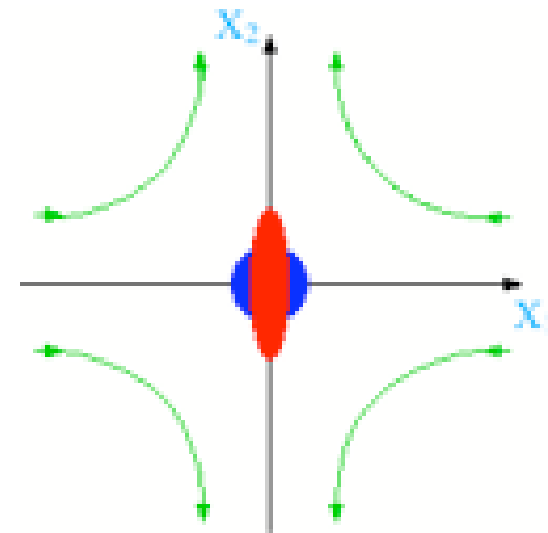

OPO squeezing

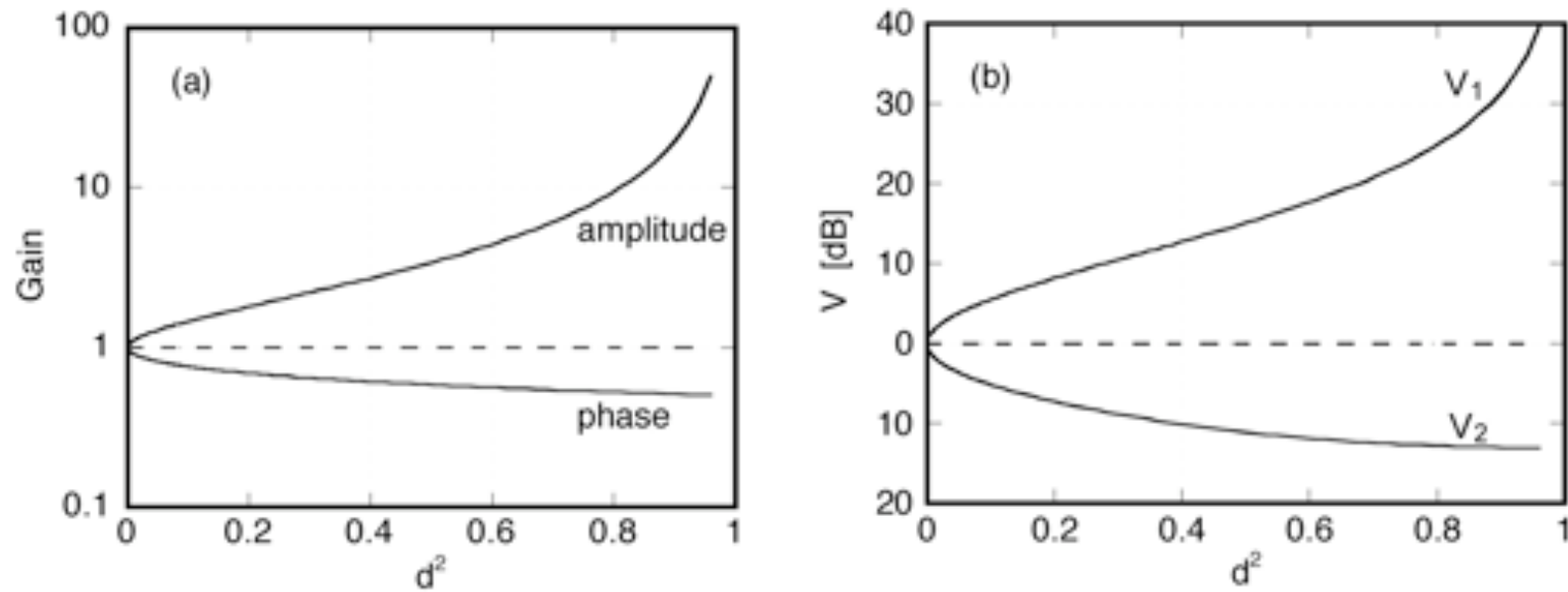

$$V_2(\Omega) = 1 - \eta \frac{4d}{(1+d)^2 + (2\pi\Omega)^2}$$

The experimental layout

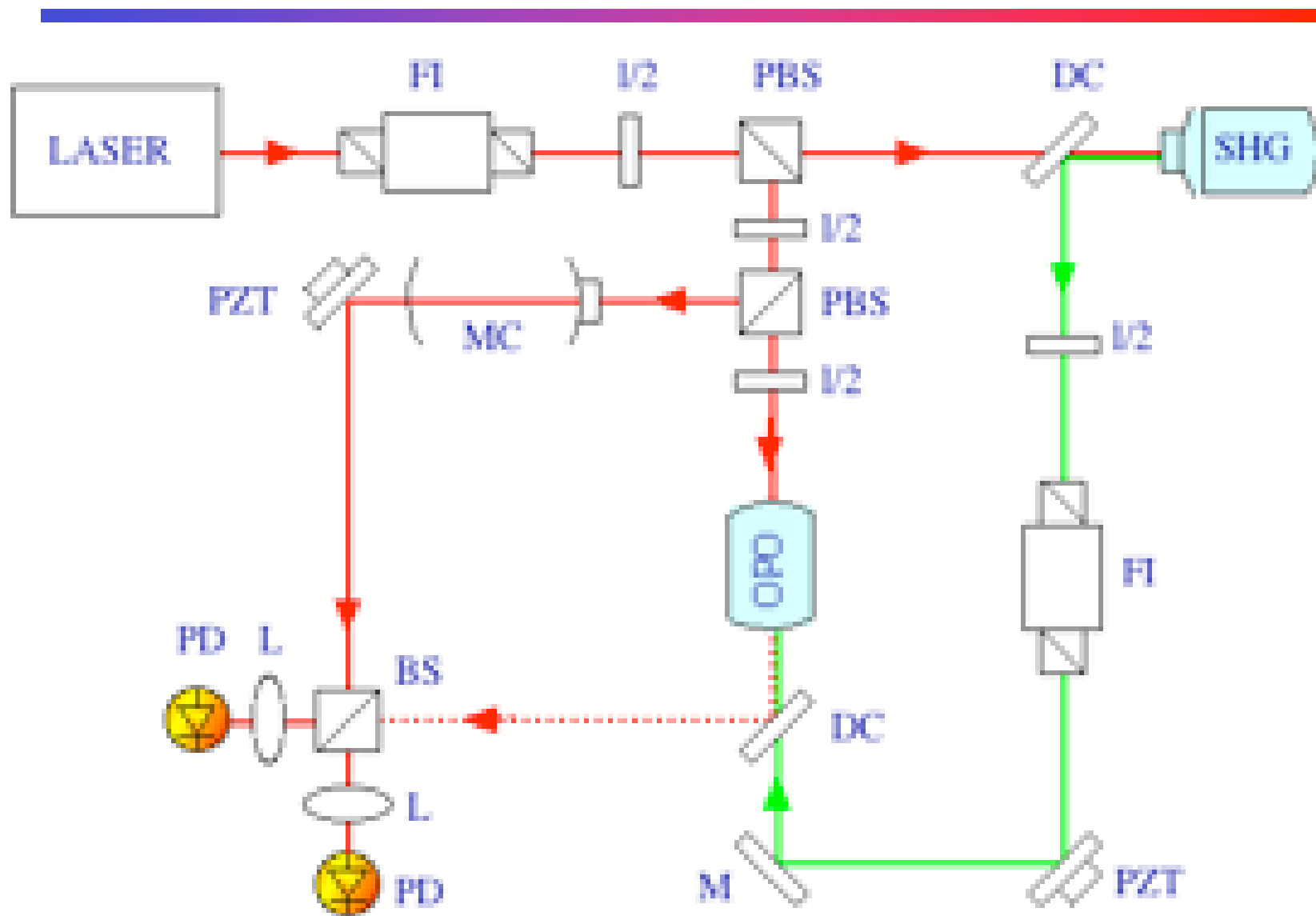

Results from OPO squeezing

- Quieter than vacuum!!
- 80% (7 dB) noise reduction for a few ms.
- 72% (5.5 dB) noise reduction when locked

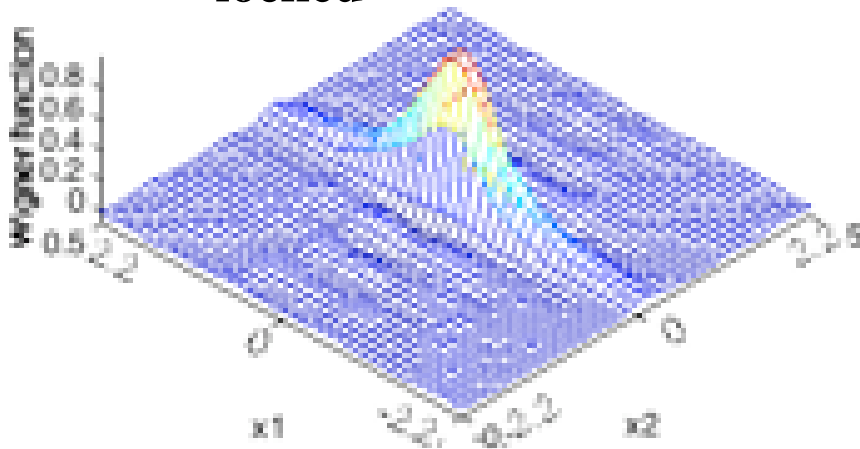
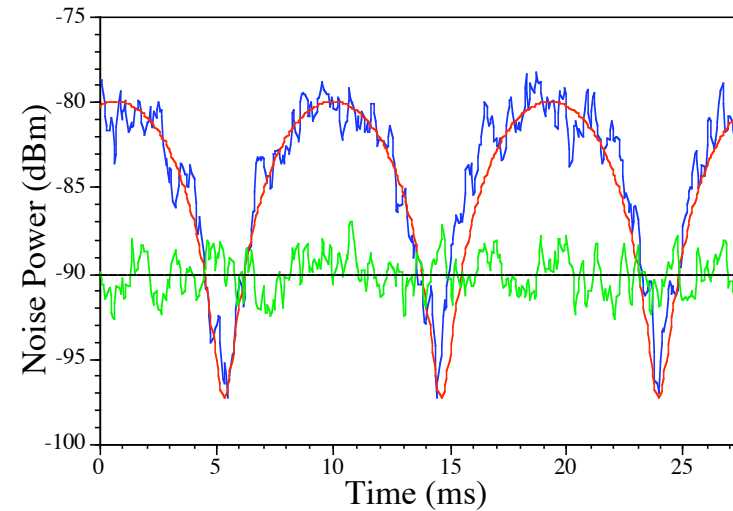

squeezed vacuum

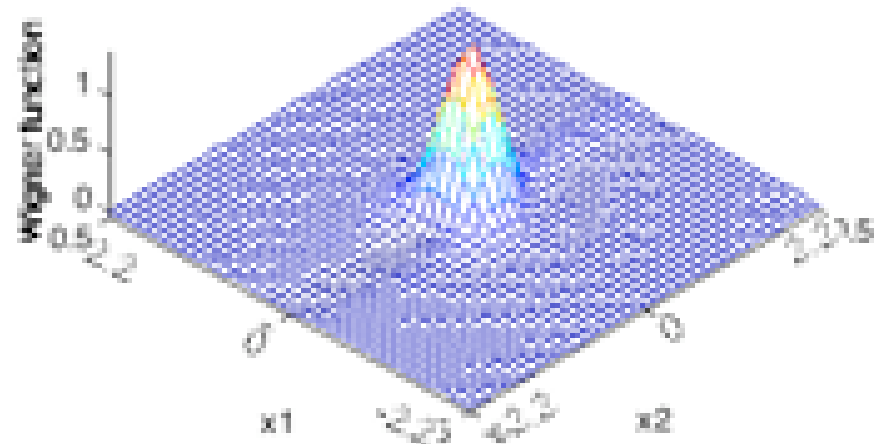

vacuum

A complete experiment

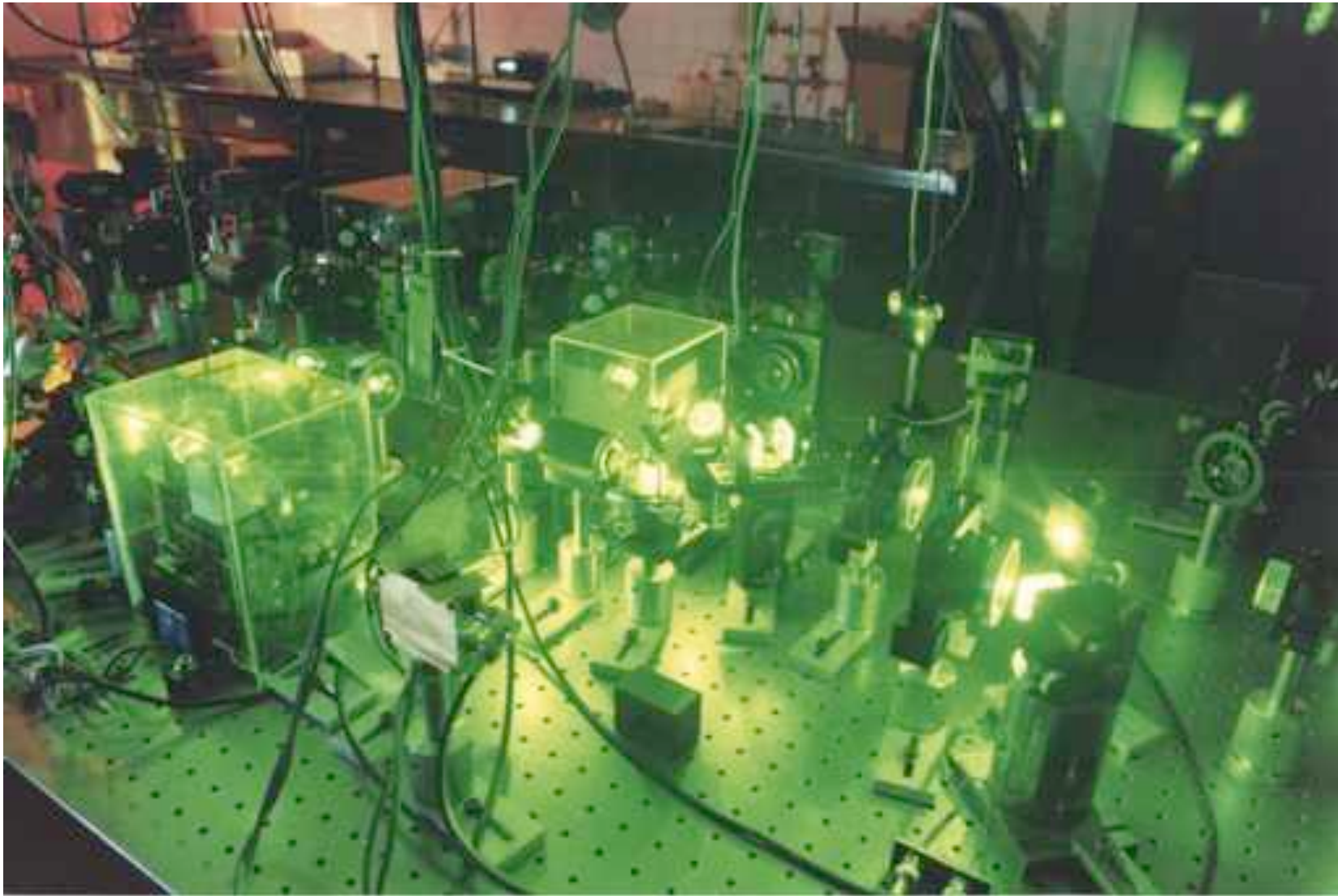

11/29/04

Example : Squeezing experiment at ANU P.K.Lam et al. 23

Effect of a beam splitter on squeezed light

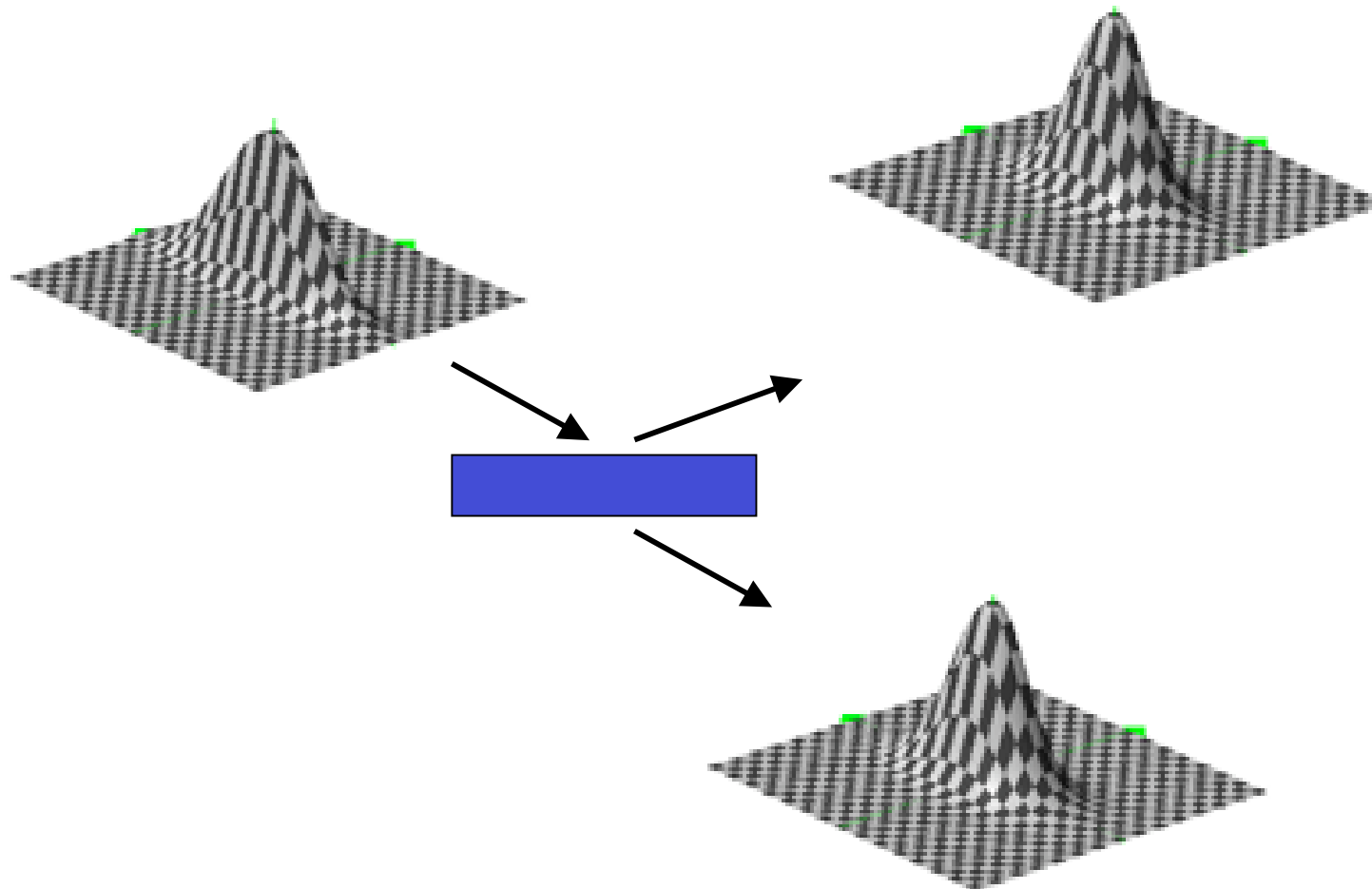

Quantitative effect of loss

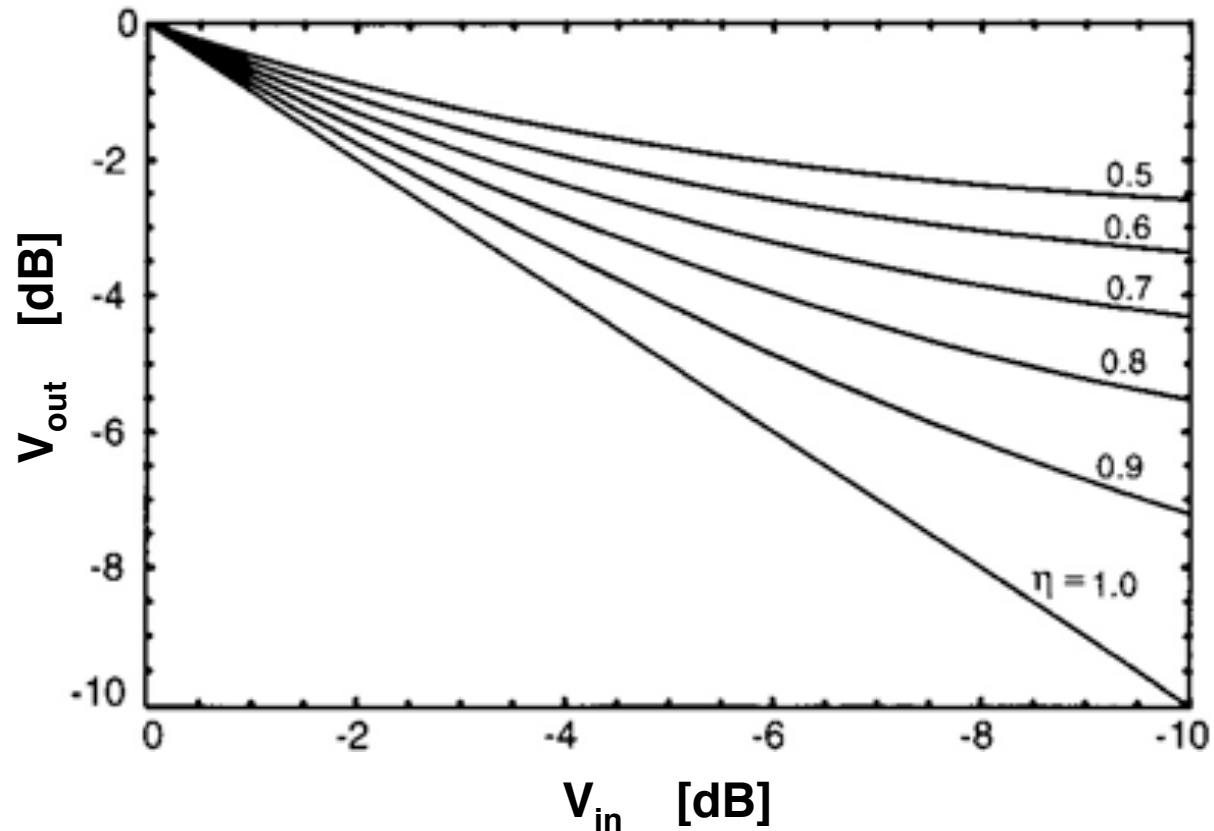

The quantitative effect of efficiencies η on the minimum variance. The squeezing values V_{in} and V_{out} are given in [dB], which is defined as $10 \log(V)$. Deep squeezing is very sensitive to any losses.

Effect of a beam splitter on squeezed light?

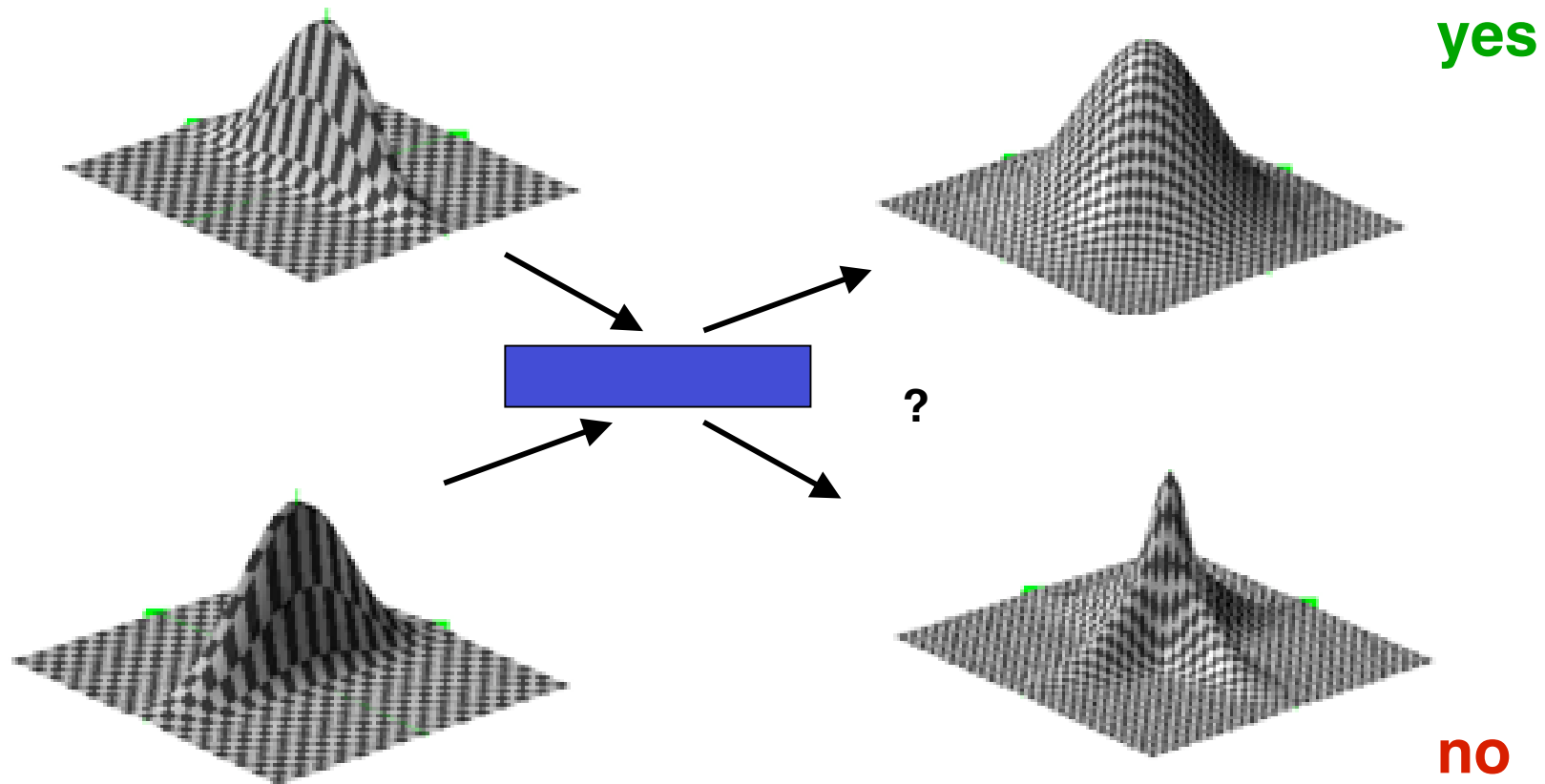

Quantum Optics 1. level

Photon statistics

Arrival times

**Poissonian
Bunching
Anti-bunching**

**Application :
Q. - cryptography**

Quantum Noise limit QNL

**Quantum noise
in photo current**

**Limit to
signal to noise ratio
SNR reduces with power**

**Limits to opt.
Instruments
(shot noise limit)**